

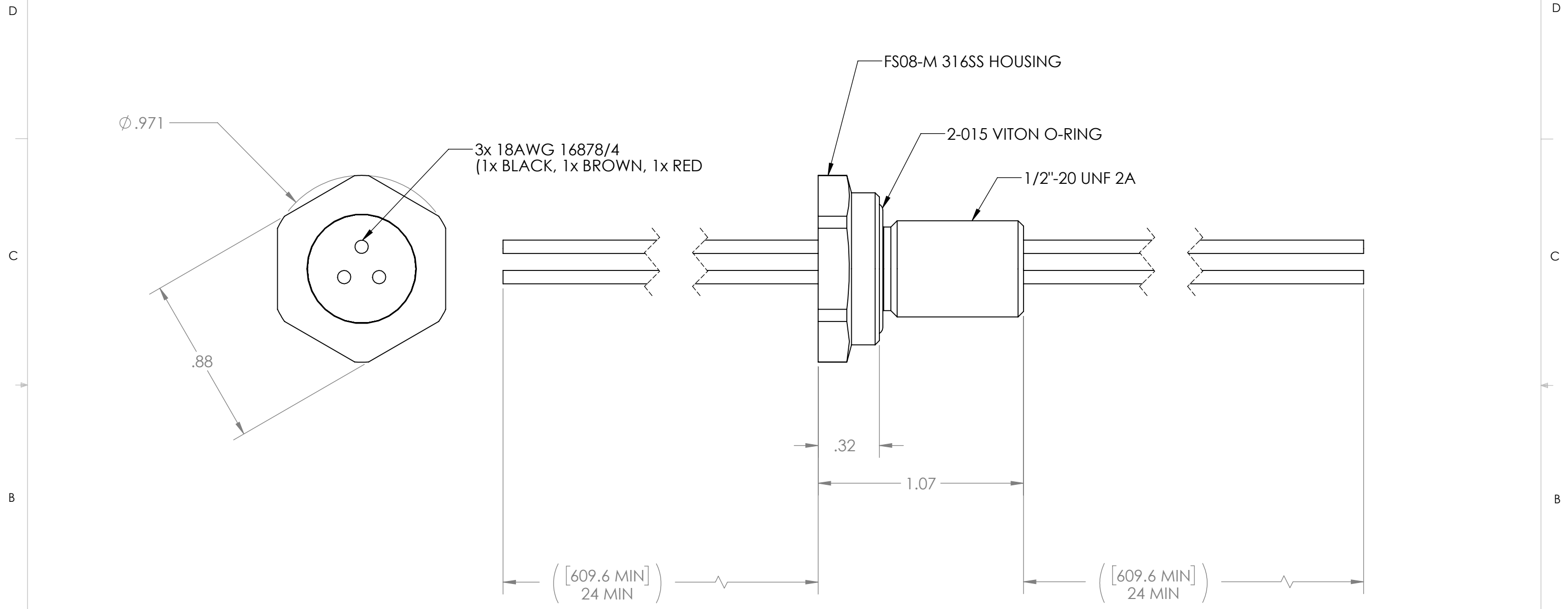

REVISIONS				
ZONE	REV.	DESCRIPTION	DATE	APPROVED
	A	INITIAL RELEASE	08Jun2022	MN



- NOTES:
1. HELIUM LEAK TEST 1X10<sup>-8</sup> STD-CC/SEC OR BETTER.
  2. HIPOT 500VDC 500 MEGOHMS 1 SECOND MINIMUM.
  3. SEAL OPERATING TEMPERATURE -20C TO 130C.
  4. DIMENSIONS ARE INCHES [MILLIMETERS], MILLIMETERS SHOWN FOR REFERENCE ONLY.
  5. CUSTOM SIZES, WIRE OR FIBER OPTIC CONFIGURATIONS, & TESTS AVAILABLE, PLEASE CONTACT RHS FOR MORE INFORMATION.

UNLESS OTHERWISE SPECIFIED:		NAME	DATE	 <b>RELIABLE HERMETIC SEALS</b>	
DIMENSIONS ARE IN INCHES		DRAWN	KS		08Jun2022
TOLERANCES:		CHECKED			
FRACTIONAL ±1/16		ENG APPR.	MN		08Jun2022
ANGULAR ±.5		MFG APPR.			
X. ±1 .X ±.1		Q.A.			
.XX ±.02 .XXX ±.005		<b>PROPRIETARY AND CONFIDENTIAL</b> THE INFORMATION CONTAINED IN THIS DRAWING IS THE SOLE PROPERTY OF RELIABLE HERMETIC SEALS. ANY REPRODUCTION IN PART OR AS A WHOLE WITHOUT THE WRITTEN PERMISSION OF RELIABLE HERMETIC SEALS IS PROHIBITED.			
INTERPRET GEOMETRIC TOLERANCING PER:		TITLE: CABLE SEAL 1/2 FS08M 316SS (3)18AWG 16878/4 24-24			
MATERIAL SEE ABOVE		SIZE	DWG. NO.	REV	
FINISH N/A		<b>B</b>	<b>60833</b>	<b>A</b>	
DO NOT SCALE DRAWING		SCALE: 2:1	WEIGHT:	SHEET 1 OF 1	